

■ 车规AD系列厚膜片式固定电阻器

Thick Film Chip Fixed Resistor Automotive Grade-AD

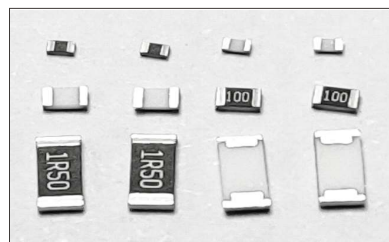

◆ 特点 Features

- * 符合AEC-Q200汽车标准相关条款 Compliant with AEC-Q200 standard
- * 体积小、重量轻 Miniature and light weight
- * 适应再流焊与波峰焊 Suit for reflow and wave flow solder
- * 电性能稳定，可靠性高 Stable electrical capability, high reliability
- * 装配成本低，并与自动贴装设备匹配 Low assembly cost, suit for automatic SMT equipment
- * 机械强度高、高频特性优越 Superior mechanical and frequency characteristics
- * 具有良好的抗硫化能力 With good sulfuration-resistant performance
- * 符合RoHS指令要求 Compliant with RoHS directive
- * 符合无卤素要求 Halogen free requirement
- * 潮敏等级：MSL 1 MSL Class:MSL 1

◆ 应用领域 Application

汽车信息系统、车载导航系统、影音娱乐系统、发动机动力控制系统、车身电子控制系统。
 Automotive information system, Vehicle navigation system, Audio-visual entertainment system, Engine power control system, Electronic body control system, etc.

◆ 型号表示方法 Part Number

AD	C	02	K	1003	F	T	13								
产品代号 Product Code	额定功率代号 Rated Power Code		型号代号 Type Code		电阻温度系数代号 T.C.R Code		电阻值代号 Resistance Value Code	电阻值误差精度代号 Resistance Tolerance Code		包装方式代号 Packaging Style Code		卷盘方式代号 Reel Style Code			
车规AD系列厚膜片式固定电阻器 Thick Film Chip Fixed Resistor Automotive Grade-AD	代号 Code	额定功率 Rated Power	代号 Code	型号 Type	型号 Type	代号 Code	T.C.R (ppm/°C)	3位数：前2位表示有效数字，第3位表示有效数字后零的个数。 Three digits: The first two digits are significant figures and the third one denotes number of zeros. 4位数：前3位表示有效数字，第4位表示有效数字后零的个数。 Four digits: The first three digits are significant figures and the four one denotes number of zeros. 小数点用R表示。Decimal point should be expressed by "R". 例如 Example: 103 = 10KΩ(E-24) 1003=100KΩ(E-96) 1R0 = 1.0Ω (E-24) 000=0Ω		代号 Code	误差精度 Tolerance	代号 Code	包装方法 Packaging Style	代号 Code	卷盘方法 Reel Style
	B	1/20W	01	0201	0201	W	±200	D	±0.5%	T	编带包装 Tape & Reel	空位	7英寸卷盘 7inch Reel		
	C	1/16W	02	0402											
	D	1/10W	03	0603											
	E	1/8W	05	0805	0402 0603 0805 1206 1210 2010 2512 0508 0612 1225	K	±100	F	±1%	T	编带包装 Tape & Reel	空位	7英寸卷盘 7inch Reel		
	Q	1/5W	06	1206											
	F	1/4W	1210	1210	J	±150	J	±5%	跨接电阻 Chip Jumper	F	0201≤35mΩ	13	13英寸卷盘 13inch Reel		
	R	1/3W	10	2010											
	G	1/2W	12	2512	L	±250	J	±50mΩ	J	≤50mΩ	13	13英寸卷盘 13inch Reel			
	H	3/4W	0508	0508											
	J	1W	0612	0612	跨接电阻 Chip Jumper		无表示 Blank								
	K	1.5W	1225	1225											
	L	2W													
N	3W														

◆ 结构 Construction

(1) 0201、0603、0805、1206、1210、2010、2512:

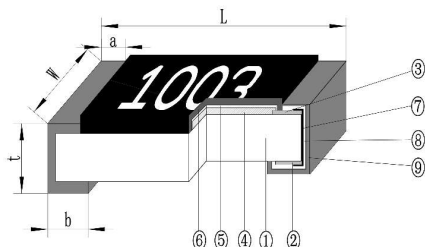

- ① 陶瓷基板 Ceramic Substrate
- ② 背电极 Bottom Electrode
- ③ 面电极 Top Electrode
- ④ 电阻体 Resistor Layer
- ⑤ 一次保护 Primary Overcoat
- ⑥ 二次保护 Secondary Overcoat
- ⑦ 端电极 Edge Electrode
- ⑧ 中间电极 Barrier Layer
- ⑨ 外部电极 External Electrode

(2) 0508、0612、1225:

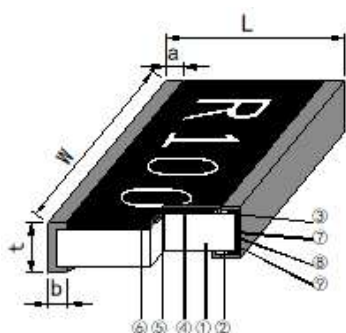

- ① 陶瓷基板 Ceramic Substrate
- ② 背电极 Bottom Electrode
- ③ 面电极 Top Electrode
- ④ 电阻体 Resistor Layer
- ⑤ 一次保护 Primary Overcoat
- ⑥ 二次保护 Secondary Overcoat
- ⑦ 端电极 Edge Electrode
- ⑧ 中间电极 Barrier Layer
- ⑨ 外部电极 External Electrode

◆ 规格尺寸 Dimensions

型号 Type	尺寸 Dimensions (mm)				
	L	W	t	a	b
0201	0.60±0.03	0.30±0.03	0.23±0.03	0.17±0.05	0.15±0.05
0402	1.00±0.05	0.50±0.05	0.35±0.05	0.25±0.10	0.25±0.10
0603	1.60±0.10	0.80±0.10	0.45±0.10	0.30±0.20	0.30±0.20
0805	2.00±0.10	1.25±0.15	0.55±0.10	0.35±0.20	0.40±0.20
1206	3.20±0.20	1.60±0.15	0.55±0.10	0.45±0.20	0.50±0.20
1210	3.20±0.20	2.50±0.20	0.55±0.10	0.45±0.20	0.50±0.20
2010	5.00±0.20	2.50±0.20	0.55±0.10	0.65±0.20	0.60±0.20
2512	6.30±0.20	3.20±0.20	0.55±0.10	0.80±0.20	0.60±0.20
2512(2W)	6.30±0.20	3.20±0.20	0.55±0.10	0.60±0.20	1.80±0.20
0508	1.25±0.10	2.00±0.15	0.55±0.10	0.30±0.20	0.30±0.20
0612	1.60±0.20	3.20±0.15	0.55±0.10	0.30±0.20	0.35±0.20
1225	3.20±0.20	6.40±0.20	0.55±0.10	0.40±0.20	0.75±0.20
1225(3W)	3.20±0.20	6.40±0.20	0.55±0.10	0.40±0.20	1.05±0.20

◆ 额定值 Ratings

型号 Type	70℃下额定功率 Rated Power at 70℃ (W)	元件极限电压 Limiting Element Voltage (V)	最大过负荷电压 Max. Overload Voltage (V)	跨接电阻70℃下额定电流 Rated Current for Chip Jumper at 70℃ (A)		跨接电阻最大过负荷电流 Max. Overload Current for Chip Jumper (A)	
				J级	F级	J级	F级
0201	1/20	25	50	0.5	0.5	1	1
0402	1/16、1/10	50	100	1	2	2	4
0603	1/10、1/8、1/5	75	150	1	3	3	6
0805	1/8、1/4	150	300	2	4	5	8
	1/2	22.36	55.90	/	/	/	/
1206	1/4、1/2	200	400	2	5	5	10
1210	1/3、1/2	200	500	2	6	5	12
2010	3/4、1	200	500	2	6	5	12
2512	1、1.5、2	200	500	2	6	5	12
0508	1/3、1/2	150	200	/	/	/	/
	1	5.48	13.69	/	/	/	/
0612	1	200	400	2	5	5	10
1225	2、3	200	400	2	6	5	12
注 Note	1、电压、电流为直流或交流有效值。 Voltage of DC or AC RMS value. 2、 $E = \sqrt{P \times R}$ 或元件极限电压两者中的较小值。 $E = \sqrt{P \times R}$ or Limiting element voltage whichever is lower. E: 额定电压 Rated voltage(V) P: 额定功率 Rated power(W) R: 标称阻值 Normal resistance(Ω) 3、0805型號1/2W可生產阻值範圍: $1\Omega < R < 1K\Omega$ Resistance range of 0805 (1/2W): $1\Omega < R < 1K\Omega$ 0508型號1W可生產阻值範圍: $1\Omega < R < 30\Omega$ Resistance range of 0508 (1W): $1\Omega < R < 30\Omega$						

型号 Type	阻值范围 Resistance Range	电阻温度系数 T.C.R (ppm/℃)		
		标称阻值允许偏差 Resistance Tolerance		
		±0.5%	±1%	±5%
0201	$1\Omega \leq R < 10\Omega$	/	±400	±400
	$10\Omega \leq R \leq 1M\Omega$	±200	±200	±200
	$1M\Omega < R \leq 10M\Omega$	/	±400	±400
	0Ω (跨接电阻Jumper)	/		
0402、0603 0805、1206 1210、2010 2512	$1\Omega \leq R < 10\Omega$	/	±200 or ±250	±200 or ±250
	$10\Omega \leq R \leq 1M\Omega$	±100	±100	±100
	$1M\Omega < R \leq 10M\Omega$	/	±200 or ±250	±200 or ±250
	0Ω (跨接电阻Jumper)	/		
0508、0612	$1\Omega \leq R < 10\Omega$	/	±150	±150
	$10\Omega \leq R \leq 1K\Omega$	/	±100	±100
0612	0Ω (跨接电阻Jumper)	/		
1225	$1\Omega \leq R < 15\Omega$	/	±150	±150
	$10\Omega < R \leq 1K\Omega$	/	±100	±100
	0Ω (跨接电阻Jumper)	/		

◆ 负荷下降曲线 Derating Curve

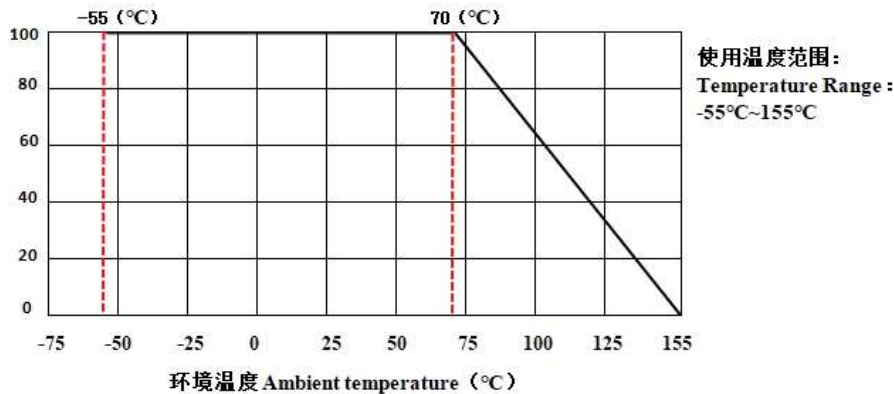

注：当电阻使用的环境温度超过70℃时，其额定负荷(额定功率或额定电流)按上述曲线下降。

Note: For resistors operated in ambient over 70℃, rated load (rated power or rated current) shall be derated in accordance with the above figure.

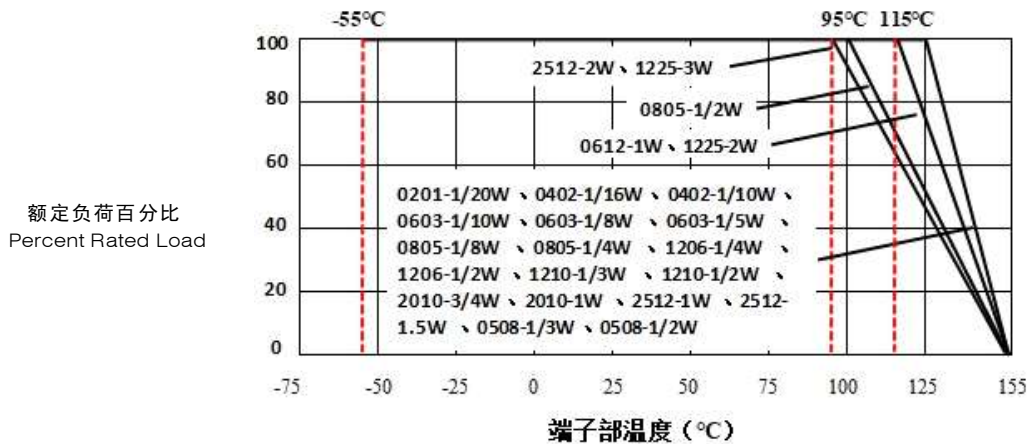

注3：超过上述额定端子部温度使用时，请根据上述功率降额曲线减少额定功率后使用。

Note 3: When exceeding the above termination temperature, please reduce the rated power according to the above power reduction curve.

◆ 单脉冲曲线 Single Pulse Curve

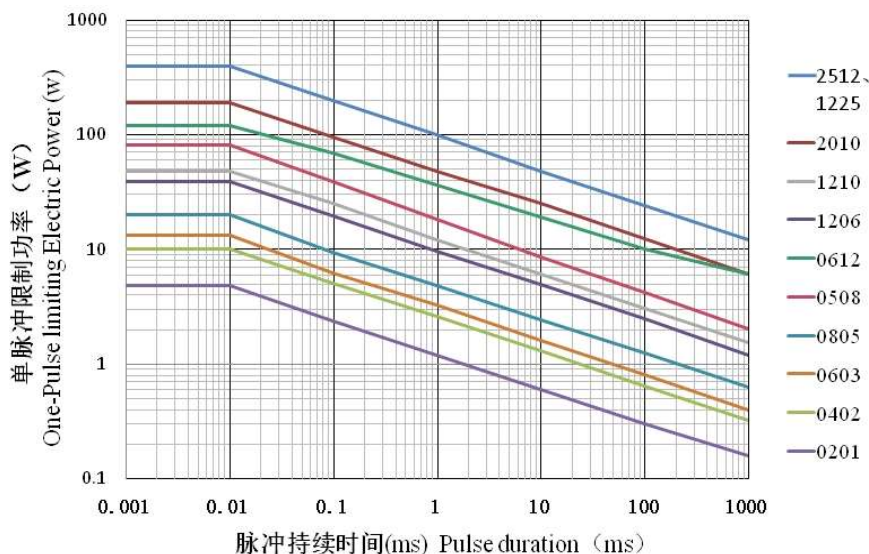

注5： $U = \sqrt{P \times R}$ 或最大过负荷电压（取较小值），此处的P指上述单脉冲曲线相对应的单脉冲限制功率；本数据为参考值，使用时需在实际机器上确认。

Note5: $U = \sqrt{P \times R}$ or maximum overload voltage (whichever is smaller), where P refers to the single pulse limited power corresponding to the above single pulse curve; This data is a reference value, which needs to be confirmed on the actual machine.

◆ 温升曲线 Temperature Rise Curve

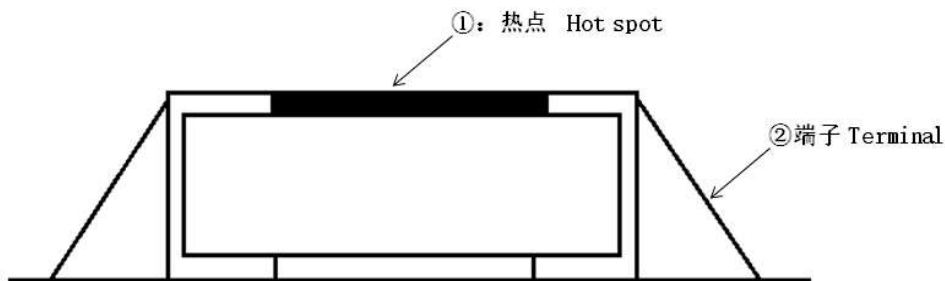
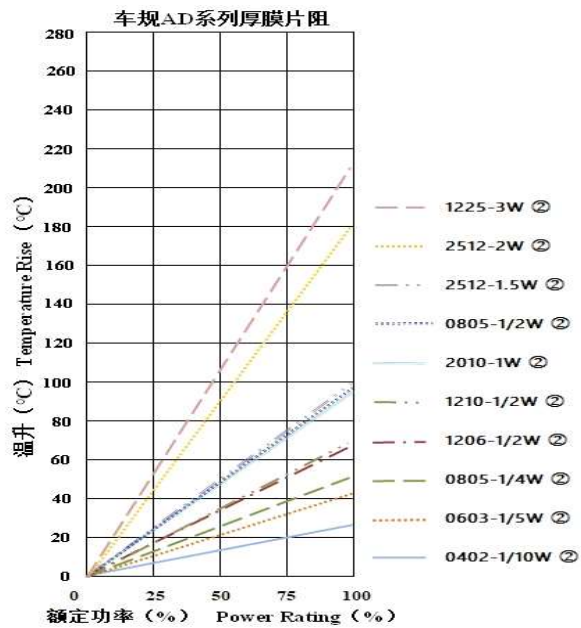
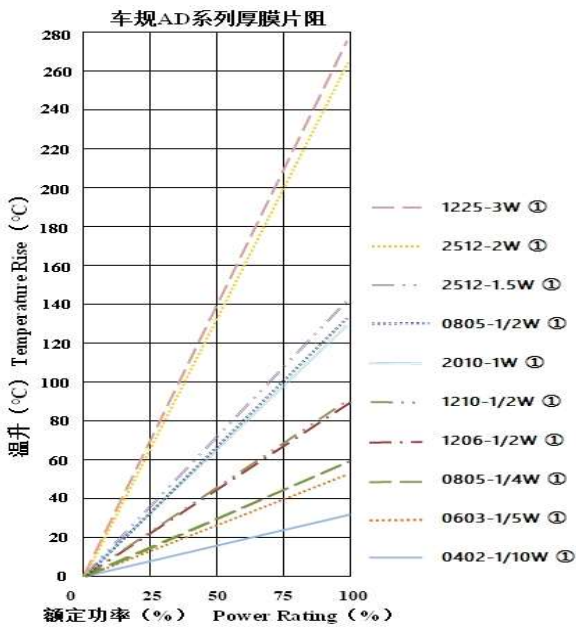
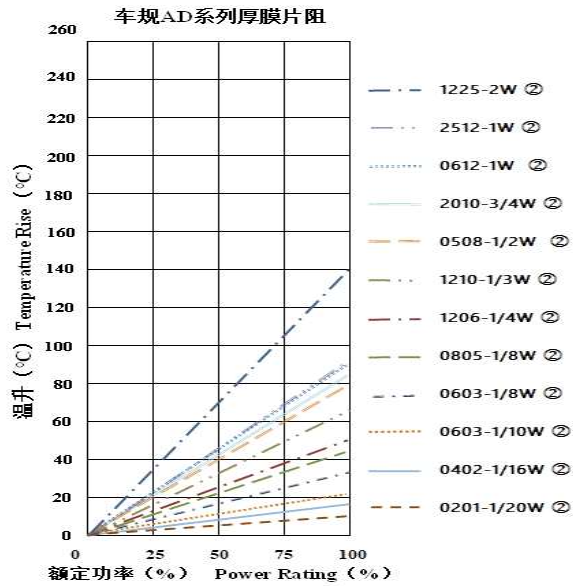
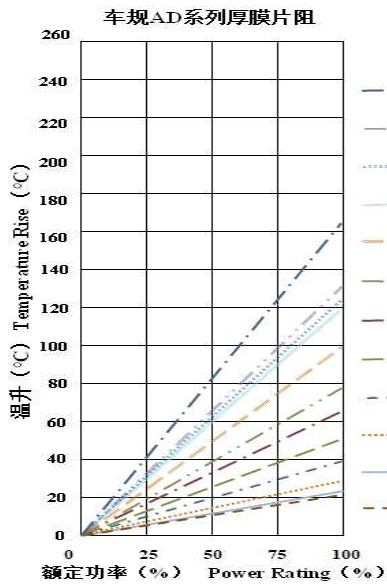

温升测试点示意图
Schematic diagram of temperature rise test points

注4: 超过表面温度上升, 由于是用本公司测试条件测定的, 根据使用状况、使用基板不同, 数值也有不同。
Note 4: When The surface temperature rises, as it is determined with the test conditions of the company, and the value varies according to the use status and the substrate.

◆ 特性 Characteristics

项目 Item	标准 Specifications		测试方法 Test Methods
	片式电阻器 Resistor	跨接电阻 Jumper	
高温存储 High Temperature Exposure (Storage)	无可见损伤 No mechanical damage 0.5%、1%: $\Delta R \leq \pm(1.0\%R+0.05\Omega)$ 5%: $\Delta R \leq \pm(2.0\%R+0.05\Omega)$	无可见损伤 No mechanical damage F级: 0201: $R \leq 70\text{ m}\Omega$ 0402及以上: $R \leq 20\text{ m}\Omega$ J级: $R \leq 100\text{ m}\Omega$	AEC-Q200 Test 3 /MIL-STD-202 Method 108 1000小时 @ T=155℃, 不通电。 1000 hrs. @ T=155℃. Unpowered.
温度循环 Temperature Cycling	无可见损伤 No mechanical damage 0.5%、1%: $\Delta R \leq \pm(0.5\%R+0.05\Omega)$ 5%: $\Delta R \leq \pm(1.0\%R+0.05\Omega)$	无可见损伤 No mechanical damage F级: 0201: $R \leq 70\text{ m}\Omega$ 0402及以上: $R \leq 20\text{ m}\Omega$ J级: $R \leq 100\text{ m}\Omega$	AEC-Q200 Test 4/JESD22 Method JA-104 预处理: 2次回流焊。 Pretreatment: two times reflow soldering. -55℃(30分钟)~常温(≤1分钟)~155℃(30分钟), 1000个循环。 -55℃(30min) ~ normal temperature(≤ 1min) ~ 155℃(30min), 1000 cycles.
高温高湿 Biased Humidity	无可见损伤 No mechanical damage $\Delta R \leq \pm(3.0\%R+0.05\Omega)$	无可见损伤 No mechanical damage F级: 0201: $R \leq 70\text{ m}\Omega$ 0402及以上: $R \leq 20\text{ m}\Omega$ J级: $R \leq 100\text{ m}\Omega$	AEC-Q200 Test 7/ MIL-STD-202 Method 103 预处理: 2次回流焊 Pretreatment: two times reflow soldering. 温度: 85℃, 湿度85%的条件下施加10%额定功率(电流)下的电压值或元件极限电压(取较小值), 放置1000小时, 通1.5小时/断0.5小时。 85℃/85%RH, Apply 10% of operating power or limiting element voltage for 1000 hours, 1.5hour on, 0.5hour off.
工作寿命 Operational Life	无可见损伤 No mechanical damage 0.5%、1%: $\Delta R \leq \pm(1.0\%R+0.05\Omega)$ 5%: $\Delta R \leq \pm(3.0\%R+0.05\Omega)$	无可见损伤 No mechanical damage F级: 0201: $R \leq 70\text{ m}\Omega$ 0402及以上: $R \leq 20\text{ m}\Omega$ J级: $R \leq 100\text{ m}\Omega$	AEC-Q200 Test 8/ MIL-STD-202 Method 108 预处理: 2次回流焊 Pretreatment: two times reflow soldering. 125℃±2℃, 1000小时, 36% 额定功率(电流)下的电压值或元件极限电压(取较小值), 通1.5小时/断0.5小时。 125℃±2℃, 1000h, 36% of rated power or limiting element voltage whichever is lower for 1.5h ON/0.5h OFF.
耐溶剂性 Resistance to Solvents	标志清晰, 无可见损伤 Clearly marked, No mechanical damage		AEC-Q200 Test 12/ MIL-STD-202 Method 215 浸在三种溶剂3min后擦拭10次, 浸、刷共3回来, 用水清洗清洗剂进行清洗, 并且室温下对整个表面进行通风干燥。 Immersed in three solvents after 3min immersion, brush wipe 10 times, a total of 3 times, washing with washing and cleaning agent, room temperature on the surface of the ventilation drying.
机械冲击 Mechanical Shock	无可见损伤 No mechanical damage $\Delta R \leq \pm(1.0\%R+0.05\Omega)$	无可见损伤 No mechanical damage F级: 0201: $R \leq 35\text{ m}\Omega$ 0402及以上: $R \leq 10\text{ m}\Omega$ J级: $R \leq 50\text{ m}\Omega$	AEC-Q200 Test 13/ MIL-STD-202 Method 213 正半弦波, 峰值加速度: 100g' s, 脉冲持续时间: 6ms, 三轴六向各3次, 共18次。 Positive half wave, peak acceleration: 100g' s, pulse duration: 6ms, three axis six to each 3 times, a total of 18 times.
振动 Vibration	无可见损伤 No mechanical damage $\Delta R \leq \pm(1.0\%R+0.05\Omega)$	无可见损伤 No mechanical damage F级: 0201: $R \leq 35\text{ m}\Omega$ 0402及以上: $R \leq 10\text{ m}\Omega$ J级: $R \leq 50\text{ m}\Omega$	AEC-Q200 Test 14/ MIL-STD-202 Method 204 预处理: 2次回流焊 Pretreatment: two times reflow soldering. 频率: 10Hz~2000Hz, 加速度: 5 g' s, 一个循环20min, X、Y、Z 三个方向每个方向12个循环, 共36个循环。 Frequency: 10Hz ~ 2000Hz, acceleration: 5 g' s, a loop 20min, X, Y, Z three directions, each direction 12 cycles, 36 cycles.
耐焊接热 Resistance to Soldering Heat	无可见损伤 No mechanical damage 0.5%、1%: $\Delta R \leq \pm(0.5\%R+0.05\Omega)$ 5%: $\Delta R \leq \pm(1.0\%R+0.05\Omega)$	无可见损伤 No mechanical damage F级: 0201: $R \leq 35\text{ m}\Omega$ 0402及以上: $R \leq 10\text{ m}\Omega$ J级: $R \leq 50\text{ m}\Omega$	AEC-Q200 Test 15/ MIL-STD-202 Method 210 270℃±5℃锡槽, 保持10s±1s。 Lead-free solder bath at 270℃±5℃ for 10s±1s.

◆ 特性 Characteristics

项目 Item	标准 Specifications		测试方法 Test Methods
	片式电阻器 Resistor	跨接电阻 Jumper	
热冲击 Thermal Shock	无可见损伤 No mechanical damage 0.5%、1%: $\Delta R \leq \pm(0.5\%R+0.05\Omega)$ 5%: $\Delta R \leq \pm(1.0\%R+0.05\Omega)$	无可见损伤 No mechanical damage F级: 0201: $R \leq 35\text{ m}\Omega$ 0402及以上: $R \leq 10\text{ m}\Omega$ J级: $R \leq 50\text{ m}\Omega$	AEC-Q200 Test 16/MIL-STD-202 Method 107 -55°C(15分钟)~常温(≤ 20 秒)~155°C(15分钟), 300个循环。 -55°C(15min)~normal temperature(≤ 20 s)~155°C(15min), 300 cycles.
ESD 静电放电 Electrostatic Discharge (ESD)	无可见损伤 No mechanical damage $\Delta R \leq \pm(3.0\%R+0.05\Omega)$	无可见损伤 No mechanical damage F级: 0201: $R \leq 35\text{ m}\Omega$ 0402及以上: $R \leq 10\text{ m}\Omega$ J级: $R \leq 50\text{ m}\Omega$	AEC-Q200 Test 17/AEC-Q200-002 人体模式, 两次放电, 正、负极性各1次。 Human body model, 1 pos + 1 neg. discharges. 0201:0.5kV;0402/0603: 1kV ;0508:1.5kV; 0805/0612/1225:2kV;1206/1210/2010/2512:3kV.
可焊性 Solderability	无可见损伤 No mechanical damage 可焊面积 $>95\%$ 95% Cover Min		AEC-Q200 Test 18/IEC 60115-1 4.17 245°C $\pm 5^\circ\text{C}$ 锡槽, 保持3s ± 0.3 s. Lead-free solder bath at 245°C $\pm 5^\circ\text{C}$ for 3s ± 0.3 s.
电阻温度系数 T.C.R	在规定值内 Within specified T.C.R	/	AEC-Q200 Test 19/IEC 60115-1 4.8 +20°C/-55°C/+20°C/+125°C/+20°C
可燃性 Flammability	不完全燃尽, 薄垫纸应不被引燃, 松木板应不被烤焦炭化。 No ignition of the tissue paper or scorching or the pinewood board.		AEC-Q200 Test 20/UL-94 V-0或V-1可接受。不需要电气测试。 V-0 or V-1 are acceptable. Electrical test not required.
基板弯曲试验 Substrate Bending Test	无可见损伤 No mechanical damage 0.5%、1%: $\Delta R \leq \pm(0.5\%R+0.05\Omega)$ 5%: $\Delta R \leq \pm(1.0\%R+0.05\Omega)$	无可见损伤 No mechanical damage F级: 0201: $R \leq 35\text{ m}\Omega$ 0402及以上: $R \leq 10\text{ m}\Omega$ J级: $R \leq 50\text{ m}\Omega$	AEC-Q200 Test 21/AEC-Q200-005 弯曲距离(Bending distance): 0201、0402、0603、0805: 5mm; 1206、1210:4mm;0508:3mm; 2010、2512、0612:2mm;1225:1mm 保持时间(Duration): 60s ± 5 s
端子强度 Terminal Strength	无可见损伤 No mechanical damage 0.5%、1%: $\Delta R \leq \pm(0.5\%R+0.05\Omega)$ 5%: $\Delta R \leq \pm(1.0\%R+0.05\Omega)$	无可见损伤 No mechanical damage F级: 0201: $R \leq 35\text{ m}\Omega$ 0402及以上: $R \leq 10\text{ m}\Omega$ J级: $R \leq 50\text{ m}\Omega$	AEC-Q200 Test 22/AEC-Q200-006 0201施加力: 2N, 保持60 ± 1 秒。 0402施加力: 5N, 保持60 ± 1 秒。 0603及以上施加力: 17.7N, 保持 60 ± 1 秒。 For 0201:Applying force 2N for 60s ± 1 s. For 0402:Applying force 5N for 60s ± 1 s. For 0603 and above size:Applying force 17.7N for 60s ± 1 s.
阻燃性 Flame Retardance	不可燃 No flame		AEC-Q200 Test 24/AEC-Q200-001 9Vdc 到 32Vdc (钳位电流高达 500A)、增量为 1.0Vdc 的电压。每种电压等级最少施加1小时。 Subjected to voltage from 9.0 to 32.0 VDC(current clamped up to 500A), and each voltage level shall be increased in 1.0 VDC for one hour minimum.
绝缘电阻 Insulation Resistance	1000M Ω Min		IEC 60115-1 4.6 在电极与基片间施加100V ± 15 V直流电压, 保持1分钟, 然后测绝缘电阻值。 Apply DC 100V ± 15 V between substrate and terminations for 1min, then check insulation resistance.
耐电压 Voltage Proof	无击穿或飞弧 No breakdown or flashover		IEC 60115-1 4.7 在电极与基片间以大约100V/s的速率施加有效值为最大过 负荷电压的交流电压, 保持60s ± 5 s。 Apply max. overload voltage of AC RMS at a rate of approximately 100V/s between substrate and terminations for 60s ± 5 s.
短时间过负载 Short Time Overload	无可见损伤 No mechanical damage 0.5%、1%: $\Delta R \leq \pm(1.0\%R+0.05\Omega)$ 5%: $\Delta R \leq \pm(2.0\%R+0.05\Omega)$	无可见损伤 No mechanical damage F级: 0201: $R \leq 35\text{ m}\Omega$ 0402及以上: $R \leq 10\text{ m}\Omega$ J级: $R \leq 50\text{ m}\Omega$	IEC 60115-1 4.13 2.5倍额定电压或最大过负荷电压/电流(取较小值), 持续5秒。 2.5 times rated voltage or max. overload voltage (current) whichever is lower for 5s.

◆ 特性 Characteristics

(续上页 Continue)

项目 Item	标准 Specifications		测试方法 Test Methods
	片式电阻器 Resistor	跨接电阻 Jumper	
低温负载 Operation at Low Temperature	无可见损伤 No mechanical damage 0.5%、1%: $\Delta R \leq \pm(1.0\%R+0.05\Omega)$ 5%: $\Delta R \leq \pm(2.0\%R+0.05\Omega)$	无可见损伤 No mechanical damage F级: $0201: R \leq 35\text{ m}\Omega$ 0402及以上: $R \leq 10\text{ m}\Omega$ J级: $R \leq 50\text{ m}\Omega$	IEC 60115-1 4.36 -55°C ± 5°C, 无负载1小时, 额定电压(电流)或元件极限电压 (取较小值)45分钟, 无负载15分钟。 -55°C ± 5°C, 1h without load, rated voltage(current) or limiting element voltage whichever is lower for 45min, 15min without load.
抗硫化性能 Sulfuration Resistant	无可见损伤 No mechanical damage $\Delta R \leq \pm(5.0\%R+0.05\Omega)$	无可见损伤 No mechanical damage F级: $0201: R \leq 70\text{ m}\Omega$ 0402及以上: $R \leq 20\text{ m}\Omega$ J级: $R \leq 100\text{ m}\Omega$	预处理: 3次回流焊+100次温度循环 Pretreatment: three times reflow soldering + 100 times temperature shock. 油浴, 恒温: $105\text{ }^\circ\text{C} \pm 3\text{ }^\circ\text{C}$, 放置时间: 0201: 500小时; 0402及以上: 1000小时。 Soaked in industrial oil with sulfur substance contained in $105\text{ }^\circ\text{C} \pm 3\text{ }^\circ\text{C}$ for 500h(0201)/1000h (0402~2512).
	无可见损伤 No mechanical damage $\Delta R \leq \pm(1.0\%R+0.05\Omega)$	无可见损伤 No mechanical damage F级: $0201: R \leq 70\text{ m}\Omega$ 0402及以上: $R \leq 20\text{ m}\Omega$ J级: $R \leq 100\text{ m}\Omega$	ASTM-B-809-95: 把待测电阻放置在饱和硫蒸气内, 温度: $60\text{ }^\circ\text{C} \pm 3\text{ }^\circ\text{C}$, 湿度: $91\% \sim 93\% \text{RH}$, 放置时间: 1500小时。 ASTM-B-809-95: Place the resistor to be measured in saturated sulfurvapor, temperature: $60\text{ }^\circ\text{C} \pm 3\text{ }^\circ\text{C}$, humidity: $91\% \sim 93\% \text{RH}$, 1500hours.

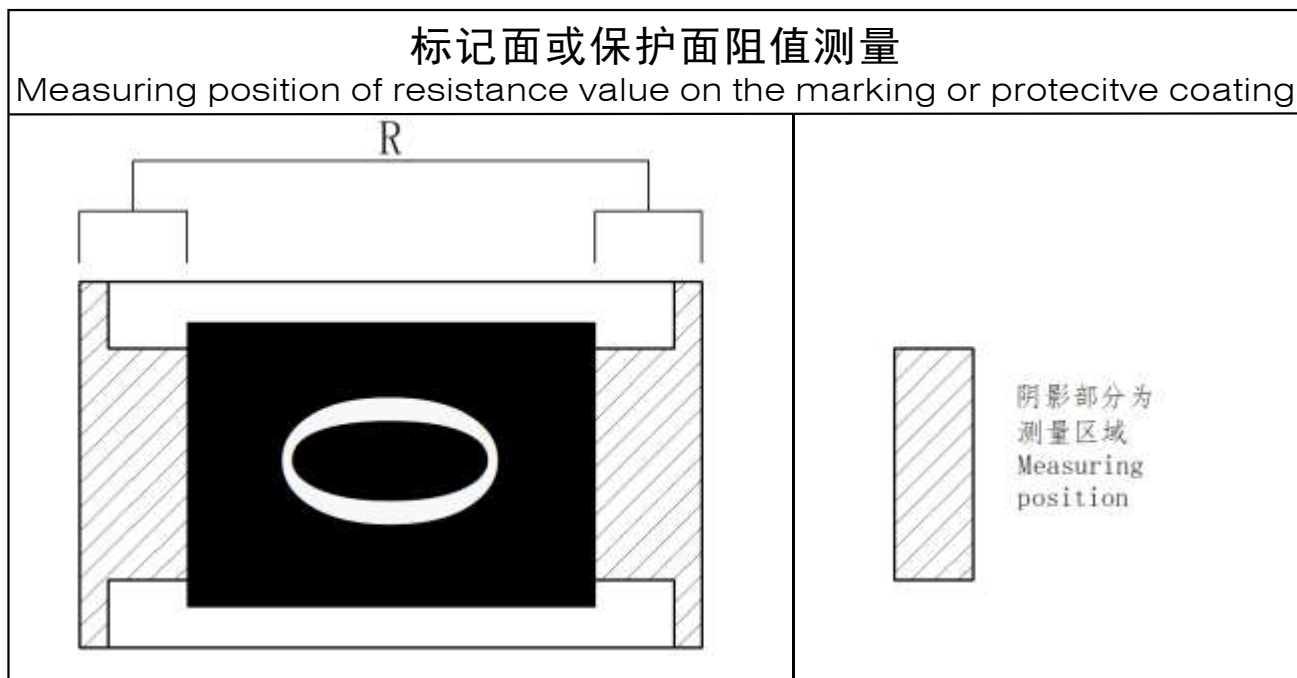
◆ 跨接电阻阻值标准测量位置 Standard Measuring Position for Resistance Value of Jumper

注: 电阻焊接后, 电阻值可能因焊盘面积、焊盘间距、焊锡量的差别而发生变化。顾客在设计电路及选型时, 必须充分而全面的考虑及评判适用性。

After soldering, the resistance value may change due to the difference of pad area, pad spacing and solder quantity. When designing circuits and selecting models, customers must comprehensively consider and evaluate the applicability.

◆ 包装 Packaging

包装方式见附录 Packaging see the Appendix.

附录 Appendix

◆ 推荐焊盘尺寸 Recommend Solder Pad Size

单位 unit: mm

- 片式固定电阻器 Chip fixed resistor

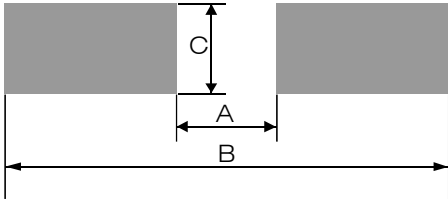

厚膜电阻及薄膜电阻 Thick Film Resistor and Thin Film Resistor			
型号Type	A	B	C
01005	0.17±0.03	0.60±0.03	0.22±0.03
0201	0.23±0.05	0.84±0.05	0.38±0.05
0402	0.45±0.05	1.45±0.05	0.60±0.05
0603	0.80±0.05	2.50±0.05	0.95±0.05
0805	1.05±0.1	3.25±0.1	1.40±0.1
1206	1.90±0.1	4.50±0.1	1.75±0.1
1210	2.00±0.1	4.60±0.1	2.70±0.1
2010	3.50±0.1	6.50±0.1	2.70±0.1
2512 (1W、1.5W)	4.80±0.1	7.80±0.1	3.40±0.1
2512 (2W)	2.70±0.1	7.80±0.1	3.60±0.1
0508	0.60±0.1	2.20±0.1	2.00±0.1
0612	0.60±0.1	2.90±0.1	3.30±0.1
1225	1.40±0.1	4.50±0.1	6.40±0.1

- 厚膜片式网络电阻器 Thick film chip network resistor

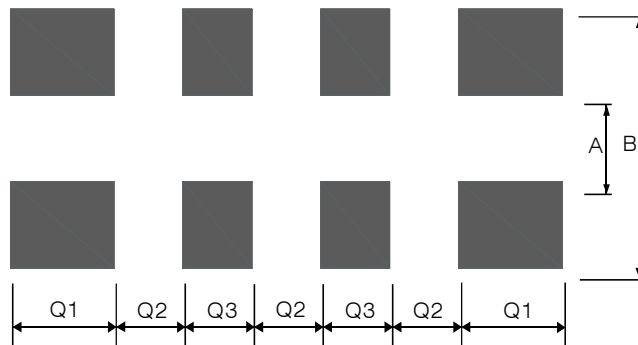

单位 unit: mm

型号 Type	A	B	Q1	Q2	Q3
2R01	0.30±0.05	0.90±0.05	0.30±0.05	0.20±0.05	---
4R01	0.30±0.05	0.90±0.05	0.20±0.05	0.20±0.05	0.20±0.05
2R02	0.35±0.05	1.25±0.05	0.65±0.05	0.20±0.05	0.30±0.05
4R02	0.38±0.05	1.60±0.05	0.40±0.05	0.20±0.05	---
4R03	0.80±0.05	2.70±0.05	0.60±0.05	0.40±0.05	0.40±0.05
备注 Remarks	1、2R01型号包含including: RC-MY04、RCMY04、RH-MY04、RHMY04 2、4R01型号包含including: RC-MY08、RCMY08、RH-MY08、RHMY08 3、2R02型号包含including: RC-MT04、RCMT04、RH-MT04、RHMT04 4、4R02型号包含including: RC-MT08、RCMT08、RH-MT08、RHMT08 5、4R03型号包含including: RC-ML08、RCML08、RH-ML08、RHML08 6、上述型号说明适用于附录中所有型号。 The above description applies to all types in the appendix.				

◆ 包装 Packaging
● 纸带编带 Paper Taping

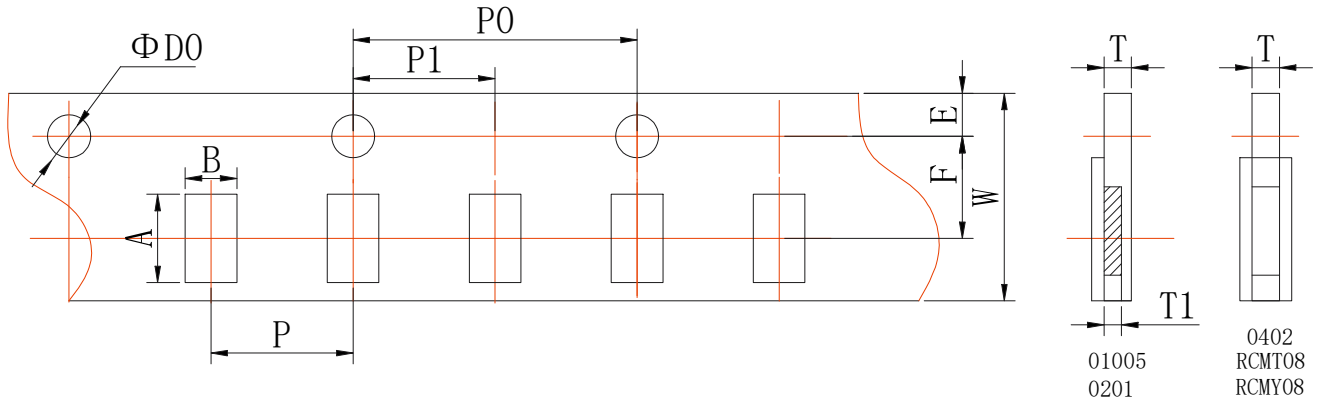
 适用于01005、0201、0402、2R01、4R01、2R02、4R02：
 For 01005、0201、0402、2R01、4R01、2R02、4R02：

单位 unit: mm

型号 Type	A	B	W	F	E
01005	0.45±0.02	0.25±0.02	8.00±0.02	3.50±0.05	1.75±0.05
0201	0.70±0.10	0.40±0.10	8.00±0.20	3.50±0.05	1.75±0.10
0402	1.15±0.10	0.65±0.10	8.00±0.20	3.50±0.05	1.75±0.10
2R01	0.97±0.05	0.77±0.05	8.00±0.20	3.50±0.05	1.75±0.10
4R01	1.57±0.05	0.77±0.05	8.00±0.20	3.50±0.05	1.75±0.10
2R02	1.45±0.10	1.20±0.10	8.00±0.20	3.50±0.05	1.75±0.10
4R02	2.20±0.10	1.20±0.10	8.00±0.20	3.50±0.05	1.75±0.10

单位 unit: mm

型号 Type	P	P0	P1	ΦD0	T1	T
01005	2.00±0.05	4.00±0.10	2.00±0.05	1.55±0.02	0.17±0.02	0.31±0.02
0201	2.00±0.05	4.00±0.10	2.00±0.05	1.50±0.10	0.28±0.04	0.42±0.05
0402	2.00±0.05	4.00±0.10	2.00±0.05	1.50±0.10	/	0.44±0.05
2R01	2.00±0.10	4.00±0.10	2.00±0.05	1.50±0.10	/	0.60±0.10
4R01	2.00±0.10	4.00±0.10	2.00±0.05	1.50±0.10	/	0.60±0.10
2R02	2.00±0.10	4.00±0.10	2.00±0.05	1.50±0.10	/	0.60±0.10
4R02	2.00±0.10	4.00±0.10	2.00±0.05	1.50±0.10	/	0.60±0.10

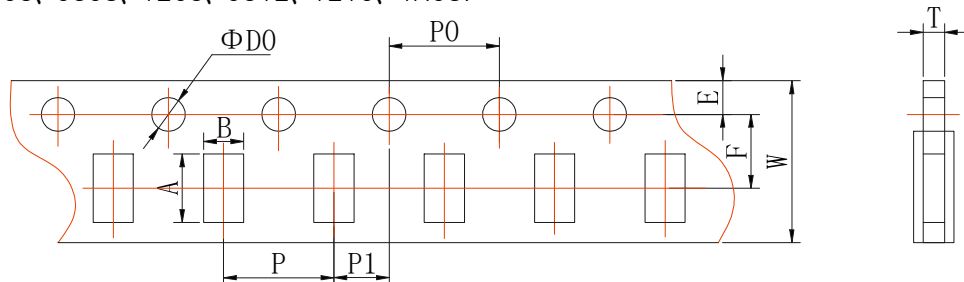
 适用于0603、0805、0508、1206、0612、1210、4R03：
 For 0603、0805、0508、1206、0612、1210、4R03：

单位 unit: mm

型号 Type	A	B	W	F	E
0603	1.80±0.10	1.05±0.10	8.00±0.20	3.50±0.05	1.75±0.10
0805	2.30±0.10	1.50±0.10	8.00±0.20	3.50±0.05	1.75±0.10
0508	2.30±0.10	1.50±0.10	8.00±0.20	3.50±0.05	1.75±0.10
1206	3.50±0.20	1.90±0.20	8.00±0.20	3.50±0.05	1.75±0.10
0612	3.50±0.20	1.90±0.20	8.00±0.20	3.50±0.05	1.75±0.10
1210	3.50±0.20	2.80±0.20	8.00±0.20	3.50±0.05	1.75±0.10
4R03	3.50±0.20	1.90±0.20	8.00±0.20	3.50±0.05	1.75±0.10

单位 unit: mm

型号 Type	P	P0	P1	ΦD0	T	
					厚膜电阻及薄膜电阻 Thick Film Resistor and Thin Film Resistor	合金片式固定电阻 Metal Foil Resistor
0603	4.00±0.10	4.00±0.10	2.00±0.05	1.50±0.10	0.60±0.10	0.75±0.10
0805	4.00±0.10	4.00±0.10	2.00±0.05	1.50±0.10	0.75±0.10	0.95±0.10
0508	4.00±0.10	4.00±0.10	2.00±0.05	1.50±0.10	0.75±0.10	0.95±0.10
1206	4.00±0.10	4.00±0.10	2.00±0.05	1.50±0.10	0.75±0.10	0.95±0.10
0612	4.00±0.10	4.00±0.10	2.00±0.05	1.50±0.10	0.75±0.10	0.95±0.10
1210	4.00±0.10	4.00±0.10	2.00±0.05	1.50±0.10	0.75±0.10	---
4R03	4.00±0.10	4.00±0.10	2.00±0.05	1.50±0.10	0.75±0.10	---

● 塑料带编带 Embossed Taping

适用于2010、2512、1225;

For 2010、2512、1225;

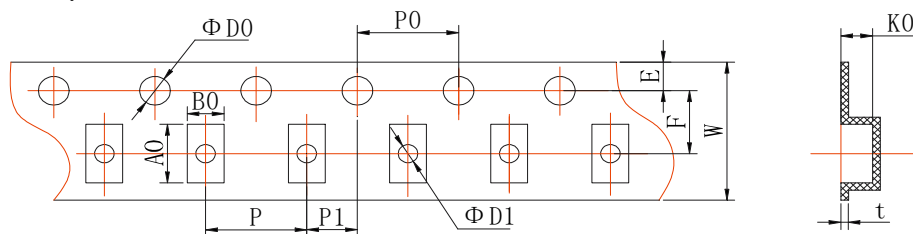

单位 unit: mm

型号 Type	A0	B0	W	F	E	t
2010	5.50±0.15	2.82±0.15	12.00±0.10	5.50±0.10	1.75±0.10	0.25±0.05
2512	6.78±0.15	3.45±0.15	12.00±0.10	5.50±0.10	1.75±0.10	0.25±0.05
1225	6.78±0.15	3.45±0.15	12.00±0.10	5.50±0.10	1.75±0.10	0.25±0.05

单位 unit: mm

型号 Type	P	P0	P1	ΦD0	ΦD1	K0	
						厚膜电阻及薄膜电阻 Thick Film Resistor and Thin Film Resistor	合金片式固定电阻 Metal Foil Resistor
2010	4.00±0.10	4.00±0.10	2.00±0.05	1.50+0.10/-0	1.50±0.10	0.84±0.10	0.84±0.10
2512	4.00±0.10	4.00±0.10	2.00±0.05	1.50+0.10/-0	1.50±0.10	0.81±0.10	1.00±0.10
1225	4.00±0.10	4.00±0.10	2.00±0.05	1.50+0.10/-0	1.50±0.10	0.81±0.10	1.00±0.10

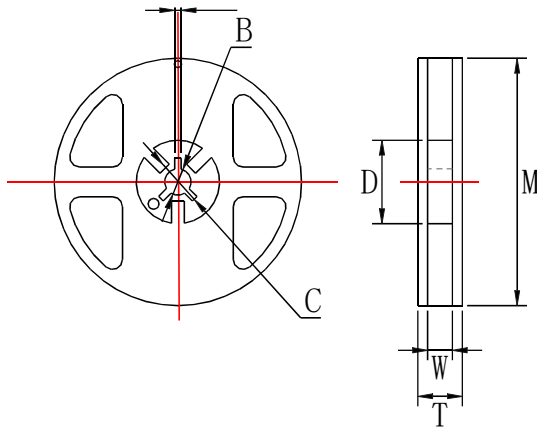
● 卷盘 Reel

单位 unit: mm

卷盘尺寸 Reel Type	型号 Type	M	W	T	A	B	C	D
7英寸 7inch dia.Reel	01005、0201 0402、0603 0805、1206 1210、2R01 4R01、2R02 4R02、4R03 0508、0612	178±2.0	9.5±1.0	12.5±1.5	2.0±0.5	13.0±0.5	21.0±0.5	58.0±2.0
	2010、2512 1225	178±2.0	13.0±0.5	15.5±1.5	2.0±0.5	13.0±0.5	21.0±0.5	57.0±2.0
13英寸 13inch dia.Reel	0201、0402 0603、0805 1206	330±2.0	9.5±1.0	13.4±1.0	2.0±0.5	13.0±0.5	21.0±0.5	100.0±1.0

● 编带包装能力 Taping Ability

面带拉力 Top tape peel strength

面带拉力强度为11~70g(0.1N~0.7N) ， 速度：300mm/min,经下列试验后不允许有破裂断带现象。

Peel strength is 11~70g (0.1N~0.7N),with speed of 300mm/min,and should not have flash and tear after peeling.

测试方法Test method:

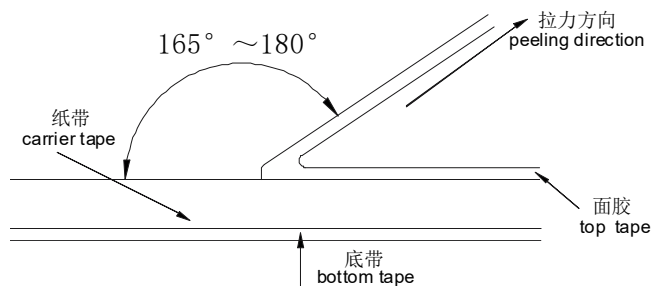

电阻松动自如，无粘面胶带、底胶带现象。

Resistor is free, no sticking to top tape and bottom tape.

电阻易从纸带中取出，且晶片孔无机械损伤。

Resistor is easy to take out from carrier tape and chip hole have no mechanical damage.

● 包装数量 Packaging Quantity

包装方法 Packaging style	7英寸卷盘 7inch dia.Reel					13英寸卷盘 13inch dia.Reel	
	01005	0201	0402、2R01 2R02、4R01 4R02	0603、0805 1206、1210 4R03、0508 0612	2010、2512 1225	0201、0402	0603、0805 1206
型号 Type	01005	0201	0402、2R01 2R02、4R01 4R02	0603、0805 1206、1210 4R03、0508 0612	2010、2512 1225	0201、0402	0603、0805 1206
数量 Quantity(pcs)	20000	15000	10000	5000	4000	50000	20000

◆ IEC E-24、E-96系列电阻值代码对照表
IEC E-24、E-96 Series Resistance Cross-reference List
● E-24 系列 E-24 series ($\times 10^n \Omega$)

 (单位 unit: 0.001 Ω 、0.01 Ω 、0.1 Ω 、1 Ω 、10 Ω 、100 Ω 、1k Ω 、10k Ω 、100k Ω 、1M Ω 、10M Ω 、100M Ω 、1000M Ω)

表一 Table One:

1.0	1.5	2.2	3.3	4.7	6.8
1.1	1.6	2.4	3.6	5.1	7.5
1.2	1.8	2.7	3.9	5.6	8.2
1.3	2.0	3.0	4.3	6.2	9.1

● E-96系列 E-96 series ($\times 10^n \Omega$)

 (单位 unit: 0.001 Ω 、0.01 Ω 、0.1 Ω 、1 Ω 、10 Ω 、100 Ω 、1k Ω 、10k Ω 、100k Ω 、1M Ω 、10M Ω 、100M Ω 、1000M Ω)

表二 Table Two:

1.00	1.33	1.78	2.37	3.16	4.22	5.62	7.50
1.02	1.37	1.82	2.43	3.24	4.32	5.76	7.68
1.05	1.40	1.87	2.49	3.32	4.42	5.90	7.87
1.07	1.43	1.91	2.55	3.40	4.53	6.04	8.06
1.10	1.47	1.96	2.61	3.48	4.64	6.19	8.25
1.13	1.50	2.00	2.67	3.57	4.75	6.34	8.45
1.15	1.54	2.05	2.74	3.65	4.87	6.49	8.66
1.18	1.58	2.10	2.80	3.74	4.99	6.65	8.87
1.21	1.62	2.15	2.87	3.83	5.11	6.81	9.09
1.24	1.65	2.21	2.94	3.92	5.23	6.98	9.31
1.27	1.69	2.26	3.01	4.02	5.36	7.15	9.53
1.30	1.74	2.32	3.09	4.12	5.49	7.32	9.76

● E-96系列0603型号《乘数代码对照表》及《电阻值代码对照表》

E-96 series(0603)《multiplied Cross-reference List》and《Resistance Cross-reference List》

表三 Table Three:

乘数multiplied	$\times 10^0$	$\times 10^1$	$\times 10^2$	$\times 10^3$	$\times 10^4$	$\times 10^5$	$\times 10^6$	$\times 10^7$	$\times 10^{-1}$	$\times 10^{-2}$	$\times 10^{-3}$
代码 code	A	B	C	D	E	F	G	H	X	Y	Z

表四 Table Four:

代号 Code	E-96系列电阻 E-96 resistance	代号 Code	E-96系列电阻 E-96 resistance	代号 Code	E-96系列电阻 E-96 resistance	代号 Code	E-96系列电阻 E-96 resistance
01	100	25	178	49	316	73	562
02	102	26	182	50	324	74	576
03	105	27	187	51	332	75	590
04	107	28	191	52	340	76	604
05	110	29	196	53	348	77	619
06	113	30	200	54	357	78	634
07	115	31	205	55	365	79	649
08	118	32	210	56	374	80	665
09	121	33	215	57	383	81	681
10	124	34	221	58	392	82	698
11	127	35	226	59	402	83	715
12	130	36	232	60	412	84	732
13	133	37	237	61	422	85	750
14	137	38	243	62	432	86	768
15	140	39	249	63	442	87	787
16	143	40	255	64	453	88	806
17	147	41	261	65	464	89	825
18	150	42	267	66	475	90	845
19	154	43	274	67	487	91	866
20	158	44	280	68	499	92	887
21	162	45	287	69	511	93	909
22	165	46	294	70	523	94	931
23	169	47	301	71	536	95	953
24	174	48	309	72	549	96	976

◆ 厚膜电阻阻值代码及标记规则
Description for Resistance Value Code and Marking of Thick Film Chip Resistor
● 阻值代码 Resistance Value Code



所有厚膜电阻的阻值代码与其标记是相对应的。

All the resistance value code of thick film chip resistor is corresponding with the marking .

● 标记 Marking

* E-24系列(≥ 0603 、 $\geq \pm 5\%$): 采用三位数字表示, 前二位表示电阻值有效数字, 第三位表示乘以10的次方数。

E-24 series: Express resistance value on the glass side with three digits, the first two digits should be significant and the third one denote number of zeros.

例 For example:  \longrightarrow 30K Ω  \longrightarrow 33 Ω

* E-24系列 (0603、 $\leq \pm 1\%$): 在三位数字标记下方增加下横线识别。

E-24 series(0603、 $\leq \pm 1\%$): Three digits with one short bar under marking letter.

例 For example: 

* E-96系列和E24系列 (0508、0805、0612、1206、1225、1210、2010、2512、 $\pm 1\%$ & $\pm 0.5\%$) :

▲ 采用四位数字表示, 前三位表示电阻值有效数字, 第四位表示乘以10的次方数。

E-96 series & E-24 series (0508、0805、0612、1206、1225、1210、2010、2512、 $\pm 1\%$ & $\pm 0.5\%$):

Express the resistance value with four digits, the first three digits are significant figures and the fourth denotes the number of zeros.

例 For example:  \longrightarrow 100K Ω

* E-96系列 (0603、 $\leq \pm 1\%$):

▲ 采用三位代码表示, 前二位表示E-96系列阻值代码, 后一位字母表示乘数代码 (见表三和表四)。

Express the resistance value with three code, the first two digit code denote the resistance of E-96 series, and the third code of letter denote the multiplier



(see the table three and four).

例 For example:  \longrightarrow 2M Ω

* 小数点以“R”表示 The decimal point should be expressed by “R” .

例 For example:  \longrightarrow 5.6 Ω  \longrightarrow 22 Ω

* 跨接电阻以“0”表示 The jumper should be expressed by “0”

例 For example:  \longrightarrow 0 Ω  \longrightarrow 0 Ω

* ≤ 0402 产品不作标记 For the chip resistor(≤ 0402), there is no mark on the glass side.

例 For example: 

* 非IEC标准系列的电阻值标记表示方法: 一般以最接近IEC E24系列标称阻值的标记表示方法。

For the resistance which don't belong to IEC serial, use the resistance of IEC serial which is most close to the required resistance of non-IEC serial for replacement.

* 客户对标记有特殊要求时, 则按照协商的结果印刷标记。

To get agreement by both party if there special requirement for the marking.

◆ 薄膜电阻阻值代码及标记规则
Description for Resistance Value Code and Marking of Thin Film Chip Resistor
● 阻值代码 Resistance Value Code

所有薄膜电阻全尺寸统一采用四位数阻值代码表示。

All resistance value code of thin film chip resistor used four digits.

例 Example

TD03G4701BT

四位数代号表示，如：4701=4.7KΩ；1R50=1.5Ω

To use four digits code represent resistance value ,

例 Example 4701=4.7KΩ；1R50=1.5Ω

● 标记 Marking

* 当阻值同时存在于E24和E96系列时，优先采用E96系列。

When resistance value belongs to E24 as well as E96 series, we suggest preferentially use E96 series.

例 Example 10K=1002, ≠103

* ≥0805 产品标记 For the chip resistor (≥0805):

▲ 印刷四位数字代码；

Express the resistance value with four digits code;

例 Example



* 0603标记 Marking for 0603 Size Resistor

▲ 0603-E96系列：印刷三位字母代码；

For resistance value belongs to E96 series, express the resistance value with three digits code.

例 Example



▲ 0603-E24系列：印刷三位数字代码；

For resistance value belongs to E24 series, express the resistance value with three digits code.

例 Example



* ▲ 小数点以"R"表示 The decimal point should be expressed by"R".

例 Example



* ≤0402产品：不作标记 For the chip resistor (≤0402), there is no mark on the glass side.

例 Example



◆ 电流检测电阻阻值代码及标记规则
Description for Resistance Value Code and Marking of Current Sensing Thick Film Chip Resistor
● 阻值代码 Resistance Value Code

所有电流检测电阻全尺寸 统一采用四位数阻值代码表示。

All resistance value code of current sensing thick film chip resistor used four digits.

例 Example

RBF03MR010FT

四位数代号表示, 如: R010=10mΩ ; 30M1=30.1mΩ

To use four digits code represent resistance value ,

例 Example R010=10mΩ ; 30M1=30.1mΩ

● 标记 Marking

* E-24和E-96系列(0508、0805、0612、1206、1225、1210、2010、2512、 $\leq \pm 5\%$): 采用四位标记代码。

For the chip resistor (0508、0805、0612、1206、1225、1210、2010、2512 $\leq \pm 5\%$), when resistance value belongs to E24 and E96 series, we suggest preferentially use four digits.

标记代码 Mark Code	阻值范围 Resistance Value	示例 Sample
R00X	$1\text{m}\Omega \leq R \leq 9\text{m}\Omega$	R005=5mΩ
R0XX	$10\text{m}\Omega \leq R \leq 99\text{m}\Omega$	R033=33mΩ
RXXX	$100\text{m}\Omega \leq R \leq 999\text{m}\Omega$	R100=100mΩ
XMXX	$1\text{m}\Omega < R < 10\text{m}\Omega$ (包含小数点后两位有效数字) (Contains two significant digits after the decimal point.)	5M10=5.1mΩ
XXMX	$10\text{m}\Omega < R < 100\text{m}\Omega$ (包含小数点后一位有效数字) (Contains one significant digit after the decimal point.)	30M1=30.1mΩ

* E-24和E-96系列(0603, $\leq \pm 5\%$): 采用三位标记代码。

For the chip resistor (0603, $\leq \pm 5\%$), when resistance value belongs to E24 and E96 series, we suggest preferentially use three digits.

标记代码 Mark Code	阻值范围 Resistance Value Range	示例 Sample
V0X	$1\text{m}\Omega \leq R \leq 9\text{m}\Omega$	V05=5mΩ
VXX	$10\text{m}\Omega \leq R \leq 99\text{m}\Omega$	V33=33mΩ
RXX	$100\text{m}\Omega \leq R \leq 999\text{m}\Omega$	R10=100mΩ
XXM	$1\text{m}\Omega < R < 10\text{m}\Omega$ (包含小数点后一位有效数字) (Contains one significant digit after the decimal point.)	5M1=5.1mΩ

* ≤ 0402 产品不印刷标记。

For the chip resistor (≤ 0402), there is no mark on the glass side.

* 非IEC标准系列的电阻值标记表示方法: 一般以最接近IEC E24系列标称阻值的标记表示方法。

For the resistance which don't belong to IEC serial, use the resistance of IEC serial which is most close to the required resistance of non-IEC serial for replacement.

* 客户对标记有特殊要求时, 则按照协商的结果印刷标记。

To get agreement by both party if there special requirement for the marking.

◆片式电阻器使用说明 Chip Resistor Instructions for Use

● 本产品在以下特殊环境下应用，性能可能会受到影响：

- 1、在各种类型的液体，包括水、油、化学品、有机溶剂的使用。
- 2、在户外直接暴露在阳光的地方，或在灰尘多的地方使用。
- 3、在产品暴露的地方，有海风或腐蚀性气体，包括氯气、硫化氢、氨气、二氧化硫、二氧化氮等。
- 4、在产品暴露于静电或电磁波的地方使用。
- 5、在产生热量的部件、塑料线，或其他易燃物品附近使用。
- 6、在用树脂或其他涂层材料密封产品的情况下使用。
- 7、焊接后使用不洁焊料或使用水或水溶性清洗剂清洗产品。
- 8、片状电阻器的基材是氧化铝。由于和安装基板的热膨胀系数不同，在反复施加提供热循环等热应力时，接合部的焊锡（焊缝部）有时会发生裂纹。如果环境温度反复发生很大的变动，并且载荷反复进行ON/OFF，则需要注意龟裂的发生。因热应力而发生的龟裂，取决于所安装的焊盘的大小、焊锡量、安装基板的散热性等，因此在环境温度有很大的变化或载荷ON/OFF的条件下使用时，请充分注意以进行设计。

◆ Application of the products in a special environment can deteriorate product performance:

- 1、Use in various types of liquid, including water, oils, chemicals, and organic solvents.
- 2、Use outdoors where the products are exposed to direct sunlight, or in dusty places.
- 3、Use in places where the products are exposed to sea winds or corrosive gases, including Cl_2 , H_2S , NH_3 , SO_2 , and No_2 etc.
- 4、Use in places where the products are exposed to static electricity or electromagnetic waves.
- 5、Use in proximity to heat-producing components, plastic cords, or other flammable items.
- 6、Use involving sealing or coating the products with resin or other coating materials.
- 7、Use involving unclean solder or use of water or water-soluble cleaning agents for cleaning after soldering.
- 8、The substrate of chip resistors is alumina. Cracks may occur at the connection of solder (solder fillet portion) due to the difference of the coefficient of thermal expansion from a mounting board when heat stress like heat cycle, etc. are repeatedly given to them. Care should be taken to the occurrence of the cracks when the change in ambient temperature or ON/OFF of load is repeated. The occurrence of the crack by heat stress may be influenced by the size of a pad, solder volume, heat radiation of mounting board etc., so please pay careful attention to designing when a big change in ambient temperature and conditions for use like ON/OFF of load can be assumed.

◆ 产品使用注意事项

- 1、避免采用超过正常额定功率的功率，超过额定功率的稳态负载条件下可能会对产品性能和可靠性产生负面影响。
- 2、用镊子拿起产品时要小心，有可能会将保护或电阻体夹碎。
- 3、手动安装产品时，烙铁头勿触碰产品。
- 4、贮存条件：温度 $5^{\circ}C \sim 30^{\circ}C$ ，相对湿度30%~70%。
建议在符合上述储存条件下六个月内使用。
- 5、用于车载设备、医疗设备、航空设备以及其它涉及人身安全、或可能引起重大损失的设备上时，请务必事先与我公司联系。这些产品在这类用途中出现故障或失灵可能导致人身事故或严重损坏。

◆ Precautions on use of products

- 1、Avoid applying power exceeding normal rated power, exceeding the power rating under steady-state loading condition may negatively affect product performance and reliability.
- 2、Be careful when pick up the products with tweezers. There may be a care that the overcoat and / or the body can be chipped.
- 3、Soldering tip shall not touch the product when install product manually.
- 4、Storage conditions: T: $5^{\circ}C \sim 30^{\circ}C$, RH: 30%~70%.
The products are suggested to be used within six months when received, and the storage condition mentioned above should be followed.
- 5、Contact our sales representatives before you use our products for applications including automotive, medical equipment and aerospace equipment. Malfunction or failure of the products in such applications may cause loss of human life or serious damage.

◆ 焊接 Soldering

- 推荐的回流焊曲线 Recommended reflow profile
- 推荐的波峰焊曲线 Recommended wave solder profile

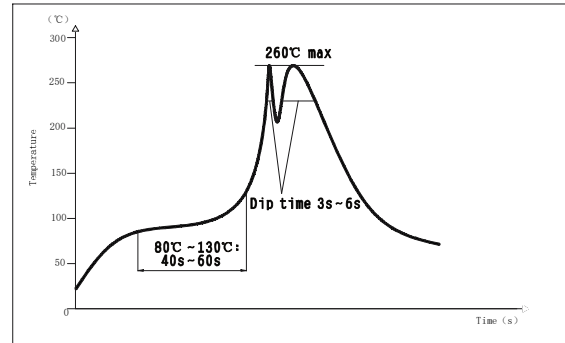
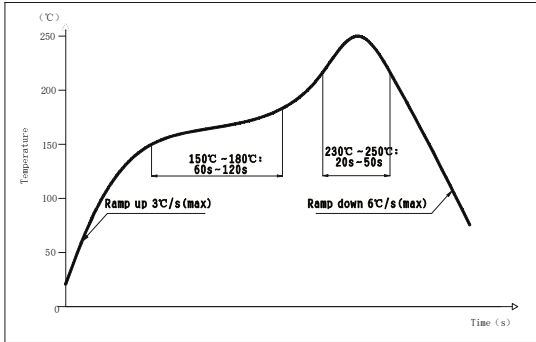

- 推荐的焊膏类型 Recommended solder alloy: 96.5Sn/3.0Ag/0.5Cu

■ 修订履历 Revision History

版本Version	日期Date	修订内容 Change Description	修改确认 Checked by
V1.0	2021-12-21	- 原版 The original version.	王跃伟 Yuewei Wang
V2.0	2022-02-25	- 附录中“包装数量”：修改0201尺寸为15K包装数量。 Revise the quantity of 0201 15Kpcs to Packaging Quantity.	杜建业 Jianye Du
V3.0	2022-03-16	- 修改“应用领域”及新增功率1/5W、1/2W、1.5W。 Revise the Application and add new rated power 1/5W、1/2W、1.5W.	王跃伟 Yuewei Wang
V4.0	2022-04-21	- 修改“额定值”中T.C.R温度系数及跨接电阻额定值表示方法。 Revise T.C.R and the parameters of Jumper.	王跃伟 Yuewei Wang
V5.0	2022-04-25	- 修改产品标记由数码体改为手写体。 Modify the product marking from digital to handwritten.	杜建业 Jianye Du
V6.0	2022-10-12	- 新增0201型号、新增0402型号1/10W 功率。 Add 0201 chip resistor, and 0402 rated power 1/10W.	王跃伟 Yuewei Wang
V7.0	2022-11-04	- 新增端子部温度曲线、温升曲线、单脉冲曲线。 Add the temperature curve, temperature rise curve and single pulse curve.	陈才华 Caihua Chen
V8.0	2023-02-20	- 附录：增加RH-MY04, RH-MY08产品编带包装参数。 Appendix: Add the taping parameters of RH-MY04, RH-MY08. - 附录：修改0201,0402,0603,0805编带包装A,B,T参数。 Appendix: Modify the taping parameters A,B,T of 0201,0402,0603,0805.	卢振强 Zhenqiang Lu
V9.0	2023-03-27	- 新增0201F级和G级阻值精度及可靠性相关判定标准。 Add 0201 Class F and Class G resistance accuracy and related reliability standards.	王跃伟 Yuewei Wang
V10.0	2023-04-04	- 增加“跨接电阻阻值标准测量位置” Add the standard measuring position for resistance value of Jumper.	王跃伟 Yuewei Wang
V11.0	2023-08-17	- 新增2512型号2W功率并更新相应参数 Add the power of 2512(2W) and update the parameters - 新增硫化实验测试方法 Add test method of sulfuration-resistant test.	王跃伟 Yuewei Wang
V12.0	2023-12-18	- 新增0508、0612、1225型号并更新相应参数。 Add the parameters of 0508,0612,1225. - 特点：增加潮敏等级MSL 1 Features:add the MSL 1 - 品名构成：增加13寸卷盘代号，删除±2%、±10%、±20%精度 Part number: add 13inch reel code,delete tolerance of ±2%、±10%、±20%. - 附录：增加13寸卷盘编带尺寸；增加0508、0612、1225包装、阻值代码及标记规则。 Appendix: add the dimentions of 13 inch reel; Add the parameters of 0508、0612、1225.	王跃伟 Yuewei Wang 卢振强 Zhenqiang Lu
V13.0	2024-03-27	- 额定值：新增0508 1W功率，修改0201型号负荷下降曲线。 Ratings:add 1W power to 0508, revised the derating curve of 0201.	王跃伟 Yuewei Wang

注：上述所提供之内容为产品规格说明。在产品未变更时，风华保有修改此内容不另行通知之所有权利，任何产品变更将会以PCN通知客户。

Remark:Information provided above is intended to indicate product specifications only. Fenghua reserves all the rights for revising this content without further notification, as long as products are unchanged. Any product change will be announced by PCN.